

# C-5RC 5.8GHz Wireless Guitar System



© 2021 Cherub Technology-All rights reserved. No part of this publication may be reproduced in any form without prior written permission of Cherub Technology.

[www.nuxefx.com](http://www.nuxefx.com) Made in China

**NUX**  
WIRELESS SYSTEM

## WARNING

To reduce the risk of fire or electric shock, do not expose this appliance to rain or moisture.

## CAUTION

This device complies with part 15 of the FCC Rules. Operation is subject to the following two conditions: (1) this device may not cause harmful interference, and (2) this device must accept any interference received, including interference that may cause undesired operation. Any changes or modifications not expressly approved by the party responsible for compliance could void the user's authority to operate the equipment.

**NOTE:** This equipment has been tested and found to comply with the limits for a Class B digital device, pursuant to Part 15 of the FCC Rules. These limits are designed to provide reasonable protection against harmful interference in a residential installation. This equipment generates, uses and can radiate radio frequency energy and, if not installed and used in accordance with the instructions, may cause harmful interference to radio communications. However, there is no guarantee that interference will not occur in a particular installation.

If this equipment does cause harmful interference to radio or television reception, which can be determined by turning the equipment off and on, the user is encouraged to try to correct the interference by one or more of the following measures:

- Reorient or relocate the receiving antenna.
  - Increase the separation between the equipment and receiver.
  - Connect the equipment into an outlet on a circuit different from that to which the receiver is connected.
  - Consult the dealer or an experienced radio/TV technician for help.
- To maintain compliance with FCC's RF Exposure guidelines, The device has been evaluated to meet general RF exposure requirement. The device can be used in portable exposure condition without restriction. Use only the supplied antenna.



The lightning symbol within a triangle means, "Electrical caution!" It indicates the presence of information about operating voltage and potential risks of electrical shock.



The exclamation point within a triangle means, "Caution!" Please read the information next to all caution signs.

## System Overview

NUX C-5RC is a wireless guitar system utilizing 5.8GHz technology. It features automatic pairing and has 30 meters /100 feet operation range (environment-dependent). With its latest algorithm update, you can enjoy a more stable wireless connection while still getting low latency, flawless, high-quality audio experience.

NUX C-5RC is tiny and portable. It's compatible with all types of instruments with a 6.35mm (1/4 inch) audio output jack, including electric guitars, electric-acoustic guitars, bass guitars, and keyboards.

Like its sibling B-5RC, the NUX C-5RC also comes with a power case to keep both the receiver and transmitter organized and charged on-the-go.

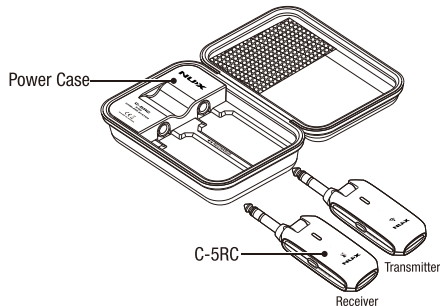

## NOTICE

2.4GHz and 5.8GHz wireless devices do not interfere with each other. However, if you're using a dual-band Wi-Fi router, please stay at least 2 meters (6 feet) away from it. To avoid dropping out, please also make sure that no walls or oversized objects block the transmitter and receiver.

## How to Operate

Matching a set of C-5RC is very easy as it is pre-paired from the factory. Just turn on the transmitter and the receiver; they should detect each other rapidly and automatically choose the best channel to establish a stable connection.

-Push and hold the power button to turn on the transmitter and the receiver.

-Before the connection is established, the LED indicator indicates the battery level. Refer to the chart below for details.

- Green – 100% > Battery >= 75%
- Yellow – 75% > Battery >= 50%
- Red – 50% > Battery >= 25%
- Red blinking for 10 times – Battery < 25%, and the unit will turn off automatically to protect battery life.

LED  100% > Battery >= 75%

LED  75% > Battery >= 50%

LED  50% > Battery >= 25%

LED  Battery < 25%

A set of fully charged C-5RC can work for roughly 4 hours. It requires 2.5 hours to get the batteries fully charged. The LED indicator lights in red during charging and the LED Indicator turns off when fully charged.

Once the connection is established, the LED indicator on both the transmitter and the receiver lights in green. In case of a failed connection, both LEDs flash in red, and you will need to establish the connection manually. (**Ref to Re-match ID & Pairing Manually for details.**)

## How to Operate

Connect the transmitter to the output of your instrument, and connect the receiver to the input of the next device in your signal flow or an output device, i.e. amplifier, guitar pedal, or mixer.

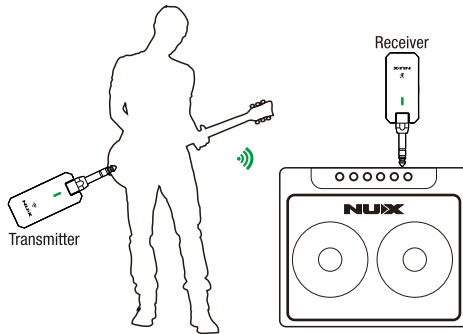

Plug the wireless system back into the power case for storage or recharge by the power case. Do remember to press the charging button on the power case to activate the charging function. The status LEDs on the power case indicates the battery level of the case. A fully charged power case can recharge the wireless system 2-3 times.

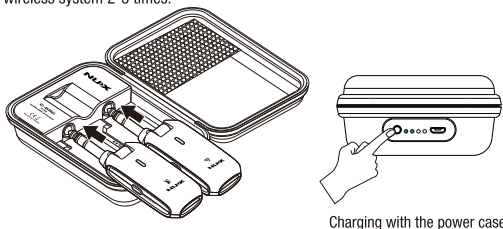

Charging with the power case.

## How to Operate

To recharge the power case, please make sure that your power adaptor has an output of 5V and 1A(or above)

You can also charge the wireless system using the included micro-b USB Y cable. Please note that C-5RC can not work during the charging process.

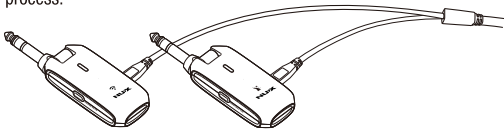

### ⚠ WARNING

The C-5RC power case can ONLY charge the NUX B-5RC and C-5RC. DO NOT plug in any other wireless systems to the power case.

### Re-Match ID & Pairing Manually

The IDs of the transmitter and the receiver of each C-5RC set have been matched in the factory. For any reason you want to re-match IDs or pair a receiver with a transmitter from different sets, follow these steps:

- Turn off the transmitter and the receiver
- Press and hold their power buttons simultaneously for 8 seconds to enter ID match status.
- If it succeeds, the LEDs on both sides turn Green.

The C-5RC set has 10 internal channels, and it will automatically detect the best channel each time it's power on. Up to 10 sets of C-5RC can be used simultaneously in ideal conditions.

### Mute function

Under working status, press the power button of the transmitter to mute the sound, and the receiver LED will turn RED. Press again to have sound again.

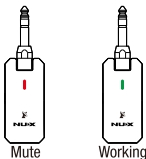

## Function Introduction

### Cabletone function

Under working status, press the power button of the receiver to activate the Cabletone function, and the LED of the receiver will turn Orange. The Cabletone function simulates the capacitor effect of a 6.4m (21 feet) cable.

Audio Precision

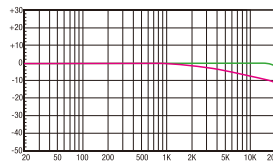

Sweep	Trace	Color	Line Style	Thick	Data	Axis	Comment
3	1	Green	Solid	3	Anti-Ampl	Left	Regular
4	1	Magenta	Solid	3	Anti-Ampl	Left	Cabletone

### Auto Off function

If there is no signal for 10 minutes, the transmitter will turn off automatically to save battery power. Since the transmitter turned off, the receiver will turn off after 10 more minutes.

### Tips for Active Pickups

- If you are using active pickups, in order to reduce noise, it is suggested to keep more distance between the transmitter and the internal circuits of your guitar or bass.

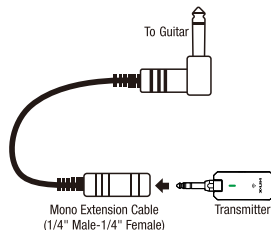

## 产品简介

- Active circuits generally use TRS output jacks, but different guitars can have different wirings to the ring and sleeve. Therefore, some guitars loaded with active pickups may not work with this type of transmitter. If this problem occurs, try to use a female to male adaptor to convert the stereo plug of the transmitter to a mono plug, and then plug into the guitar. See the picture below:

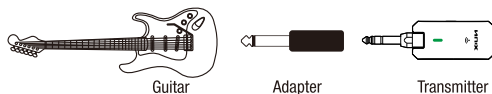

## Specifications

- 5.8GHz operating frequency
- 24bit 44.1kHz
- Latency: <5.5ms
- S/N: 110dB
- Frequency Response: 20Hz – 20kHz
- THD+ Noise < 0.2% @1kHz
- Signal Gain: 0dB
- TX/RX Battery Capacity: 500mAh / 3.7V
- TX/RX Battery run time: >4hrs
- Power Case Battery Capacity: 3000mAh / 3.7V
- Dimensions
  - Power Case: 132mm(L) x 93mm(W) x 50mm(H)
  - Transmitter/Receiver: 108mm(L) x 30mm(W) x 21mm(H)
- Weight
  - Power Case: 196g
  - Transmitter/Receiver: 34g each

### Accessories

- Micro- b USB Y cable x 1
- Manual

\*Specifications and appearance subject to change without notice.

C-5RC是一款专为吉他开发的5.8GHz音频无线传输系统。它广泛适用于电箱琴、电吉他、电贝司等吉他类产品，也可以应用在其它带有6.35mm音频输出插口的数码键盘等电声乐器。采用5.8GHz全球公共开放频段（注：日本开放频段为5.2GHz），具有自动配对和通道检测功能。其先进的算法保证了在超低延迟的前提下完成24bit 44.1kHz高品质音频的稳定信号传输。有效传输距离可达约30米。C-5RC小巧的设计非常便携，配有一个充电收纳盒，可收纳发射器和接收器，并为它们充电。

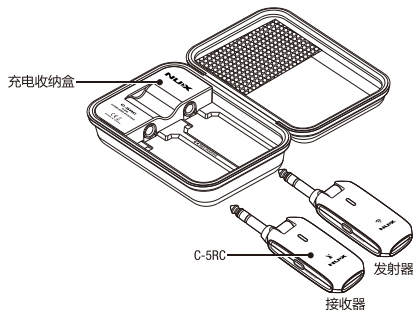

### 注意

虽然5.8GHz无线设备与2.4GHz Wi-Fi和蓝牙设备相互干扰较小，但是为了获得最佳效果，请与Wi-Fi和蓝牙设备保持至少2米以上的距离，并且应避免在发射器和接收器之间存在墙壁或大型物体阻隔。

## 操作指南

### 开机与配频

长按发射器与接收器的电源按钮可打开发射器和接收器。



打开发射器和接收器后，它们就会在几秒钟内自动配对，并自动检测出最佳工作通道。

在它们自动配对之前，您可以通过机身上LED状态灯的颜色看到当前状态下的电池容量。

LED  100% > 电量 >= 75%

LED  75% > 电量 >= 50%

LED  50% > 电量 >= 25%

LED  电量 < 25%

当LED状态灯变为红色且快速闪烁10次时，提示其电池容量已小于25%，发射器和接收器将自动关闭以保护电池寿命。

一套充满电的C-5RC可以持续工作约4小时。发射器、接收器电池充满电需要2.5小时。当电池充电时，LED状态灯为红色，充电完成后LED状态灯将熄灭。

开机1秒后，发射器和接收器将自动配对，两端的LED状态灯变为绿色，这意味着它们已经进入正常工作状态了。

在无法自动配对时，接收器LED状态灯闪烁红色，您需要手动重新配对。（请参阅：手动重新匹配ID和配对）

## 操作指南

### 使用

将发射器连接到乐器的音频输出口，将接收器连接到效果器、音量踏板等设备或音箱、调音台、声卡的输入口。

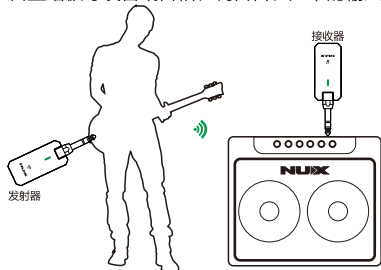

### 收纳及充电

将发射器和接收器插回充电收纳盒中即可收纳。轻按充电收纳盒上的按钮，可以对收纳其中的C-5RC充电。充电收纳盒外的LED电量提示灯显示收纳盒内置电池的当前容量状态。当LED电量提示灯只剩最后一格时，请及时为充电收纳盒充电。当充电收纳盒满电时，它可以为C-5RC音频无线传输系统完整充电2-3次。

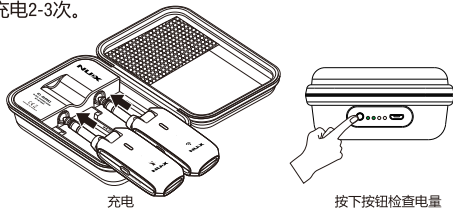

## 操作指南

为充电收纳盒充电时，请确保电源适配器的输出电压为5V，电流在1A以上。

您还可以使用附带的Y型充电线为发射器和接收器充电。充电时C-5RC将不能传输无线信号。



### 警告

C-5RC充电收纳盒只能为NUX B-5RC和C-5RC充电。请勿将任何其它无线系统插入充电收纳盒。

## 手动重新匹配ID和配对

每套C-5RC出厂时已对发射器和接收器的ID进行过匹配。如果要重新匹配ID，或将接收器与不同组的发射器配对，请执行以下步骤：

- 关闭发射器和接收器。
- 同时按住发射器和接收器的电源按钮8秒，进入ID匹配状态。
- 匹配成功后两端的LED状态灯将变为绿色。

C-5RC内置10个信道，每次通电时都会自动检测到最佳信道。在理想条件下，最多可同时使用10套C-5RC。

## 静音功能

在工作状态下，短按一下发射器电源按钮则进入静音模式，发射器及接收器的LED状态灯变为红色。再次按下则恢复声音，LED状态灯变为绿色。

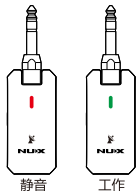

## 操作指南

## 线材模拟 (Cabletone) 功能

线材模拟功能可以模拟6.4米音频线的电容效应，让您获得真实线材传导的声音。在工作状态下，短按一下接收器的电源按钮，可激活线材模拟功能，接收器的LED状态灯变为橙色。

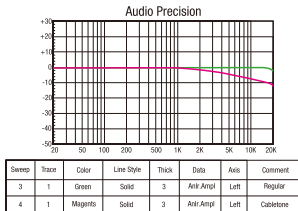

## 自动关机功能

C-5RC为了节省电池电量，设置了自动关机功能。发射器在10分钟内如果没有有效信号输入将自动关机。接收器在发射器关机10分钟后也将自动关机。

## 用于主动式拾音器的提示

- 如果您使用主动式拾音器，请让发射器与吉他或贝司的内部电路保持一定的距离，可以有效降低可能产生的噪音。（例如使用延长线等）

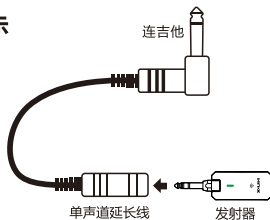

- 装有主动式拾音器的吉他一般使用TRS输出插口，但不同的吉他其内部的接线方式可能不同。因此，一些装有主动式拾音器的吉他可能无法与这种发射器的插头匹配。如果出现此问题，请尝试通过6.35mm的单声道转单声道转接头将发射器接到吉他的上。见下图：

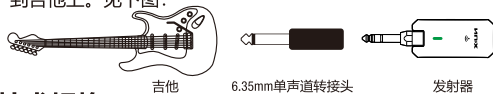

## 技术规格

- 工作频率：5.8GHz
- 采样精度：24bit
- 采样频率：44.1kHz
- 系统延时：< 5.5ms
- 发射器/接收器电池容量：500mAh / 3.7V
- 发射器/接收器电池使用时长：>4hrs
- 充电收纳盒电池容量：3000mAh / 3.7V
- 尺寸  
充电收纳盒：132mm(长) x 93mm(宽) x 50mm(高)  
发射器/接收器：108mm(长) x 30mm(宽) x 21mm(高)
- 重量：  
充电收纳盒：196g  
发射器/接收器：每个34g
- 信噪比：110dB
- 频率响应：20Hz~20kHz
- 信号失真度：<0.2%@1kHz
- 信号增益：0dB

\*技术规格如有变更，恕不另行通知。

附件：●Y形充电线1根 ●使用说明书

## 合格证

检验员

名称

5.8GHz音频  
无线传输系统

生产日期

型号

C-5RC

本产品经检验合格  
执行标准：Q/WNDZ 001-2020

## 有关产品中所含有害物质的说明

- 本资料就本公司产品中所含的特定有害物质及其安全性予以说明。
- 本资料适用于2007年3月1日以后本公司所制造的产品。

### 环保使用期限



此标志适用于在中国国内销售的电子信息产品，表示环保使用期限的年数。所谓环保使用期限是指在制造日起的预定期限内，产品中所含的有害物质不引起环境污染，不会对人身、财产造成严重的不良影响。环保使用期限仅在遵循产品使用说明，正确使用产品的条件下有效。不当的使用，将会导致有害物质泄漏的危险。

### 产品中有毒有害物质或元素的名称及含量

部件名称	有害有毒物质或元素					
	铅(Pb)	汞(Hg)	镉(Cd)	六价铬(Cr(VI))	多溴联苯(PBB)	多溴二苯醚(PBDE)
外壳(壳体)	×	○	○	○	○	○
电子部件(印刷电路板等)	×	○	×	○	○	○
附件(电源线、交流适配器等)	×	○	○	○	○	○

○：表示该有害物质在该部件所有均质材料中的含量均在SJ/T11363-2006 标准规范的限制要求以下。  
 ×：表示该有害物质至少在该部件的某一均质材料中的含量超出SJ/T11363-2006 标准规定的限量要求。  
 因根据现有的技术水平，还没有什么物质能够替代它。

## 质量承诺

亲爱的 NUX 用户：

在您使用 NUX 产品时，请仔细参阅产品说明书，当您有疑问和困难时，请拨打售后服务热线：

400-990-9866

- 一周内出现质量问题可退货退款
- 一年内出现质量问题可免费维修
- 一月内出现质量问题可调换
- 终身享有咨询和维修服务

[ 请向销售商索取有效购买凭证并予以保存 ]

## 换修政策

一、包换政策：

1. 消费者自购机之日起1个月之内，在正常使用情况下出现非人为的产品性能故障，且产品外观及包装保持完好，可向所购机器的经销商换机。
2. 消费者在换机时应出示由经销商开出的购机收据及保修卡，否则经销商可以不予更换。

二、保修政策：

1. 产品自购买之日起1年内，可免费享有维修服务。对于超过1年或人为及不可抗力因素造成损坏的产品，我司可提供有偿维修服务。

### 售后服务地址

广东省珠海市高新区唐家湾镇科技九路10号  
珠海市蔚科科技开发有限公司 售后服务部  
邮编：519085

制造商：深圳市蔚科电子科技有限公司 制造商地址：深圳市南山区蛇口兴华路6号南海意库1栋507  
电话：0755-2686 9866 网址：cn.nuxet.com 生产商：珠海市蔚科科技开发有限公司  
生产厂地址：珠海市高新区唐家湾镇科技九路10号 电话：0756-3688666 执行标准：Q/WNDZ 001-2020